

# CAMPKONSTRUKTIONEN

## 1) IESSPLATZEN

MOOSSEN:

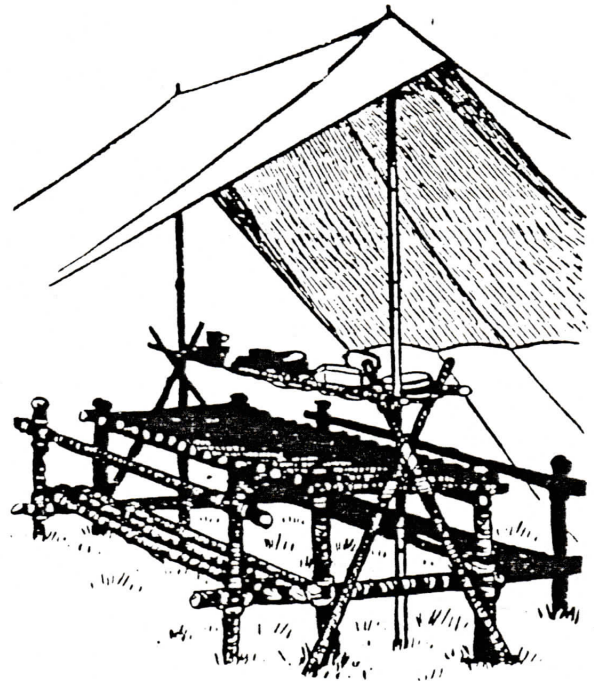
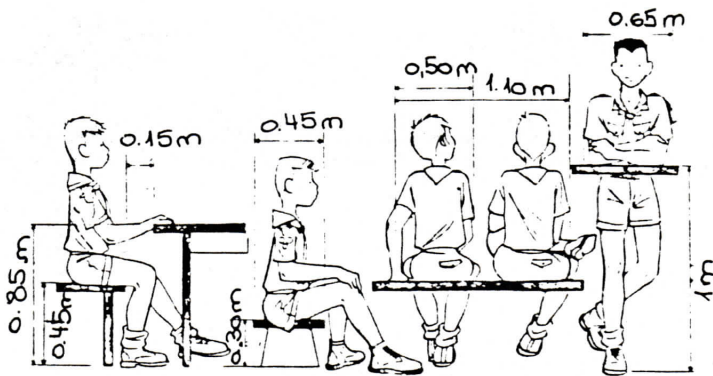
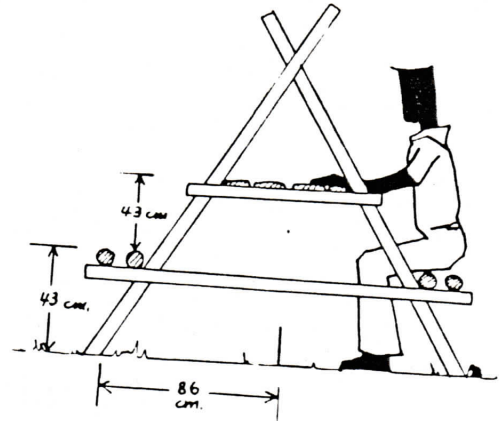
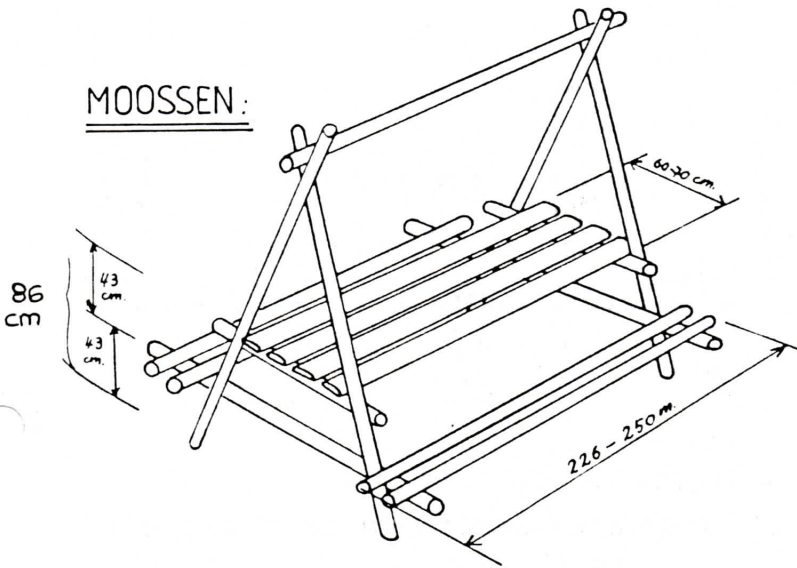

BEISPILLER:

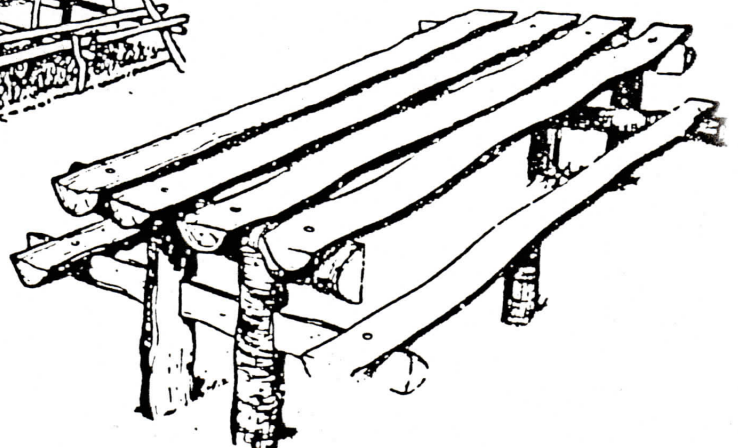
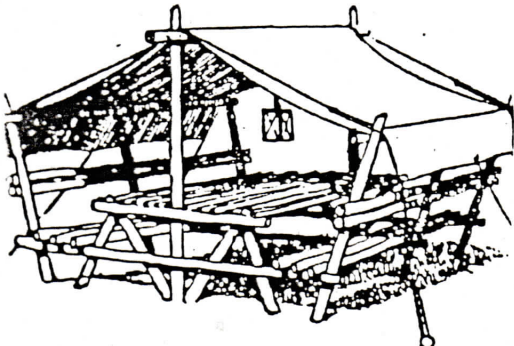
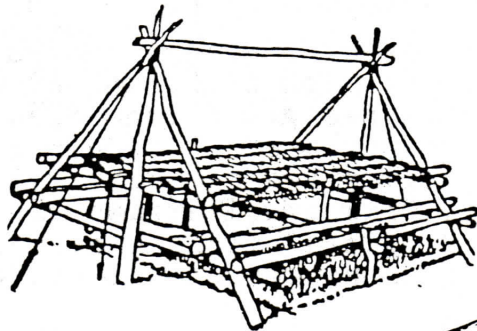

## 2) KACHPLATZEN

4 Piquet'en vun 85 cm Längt fir liicht Bauweis,  
6 Piquet'en vun 85 cm Längt ein gespötzt an an den Buedem  
ageschloen.

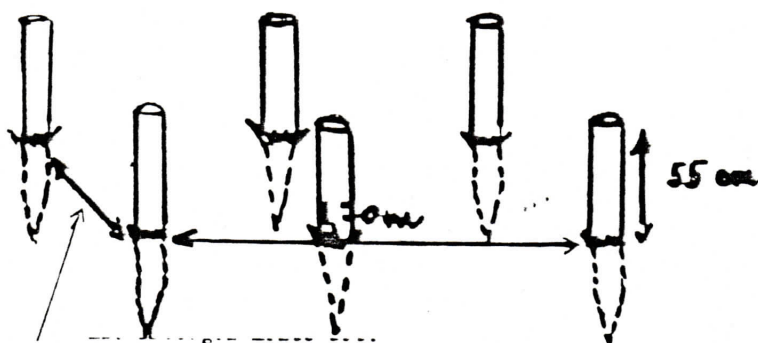

Upassen un d'Blechbréd oder Flakebréd  
2 Längsstaangen vun 2 m ein no bannen un den Piquet'en  
mat Brelagen montéiert. <sup>SAG</sup>

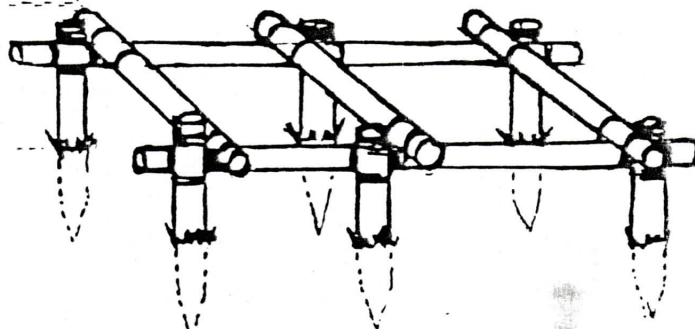

Mir verstärken déi Staangen mat décken Traversen.

Op dest Gestell léen mir den Blech  
oder soss eng Deschplak. Fir dass de  
Blech net rutscht, schloen mir op all  
Eck jeweils 2 Lächer, dann mat Droht  
un den Piquet'en festmaachen.

Dann hiewt én grouss Stécker Wues  
(10 cm déck) mam Spuet aus. Mat desém  
Wues get d'ganz Plak bedeckt, d'Gras  
no ennen, d'Lächer zougestoppt.  
Doroper ein dann Betonszillen gestalt  
fir ons Feuerlächer. Oppassen, dât se  
stabil stin an déi gleichen Héicht hun.  
Zum Schluss nach Eisenstaangen drop léen.

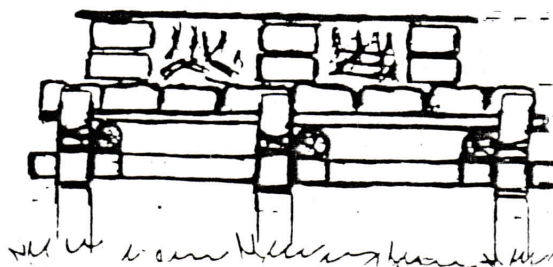

MOOSSEN:

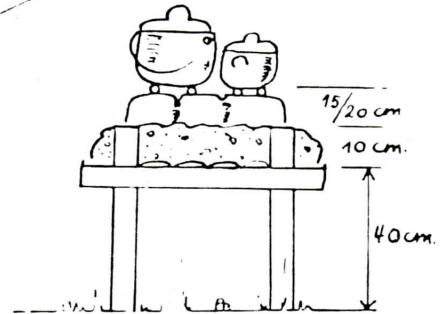
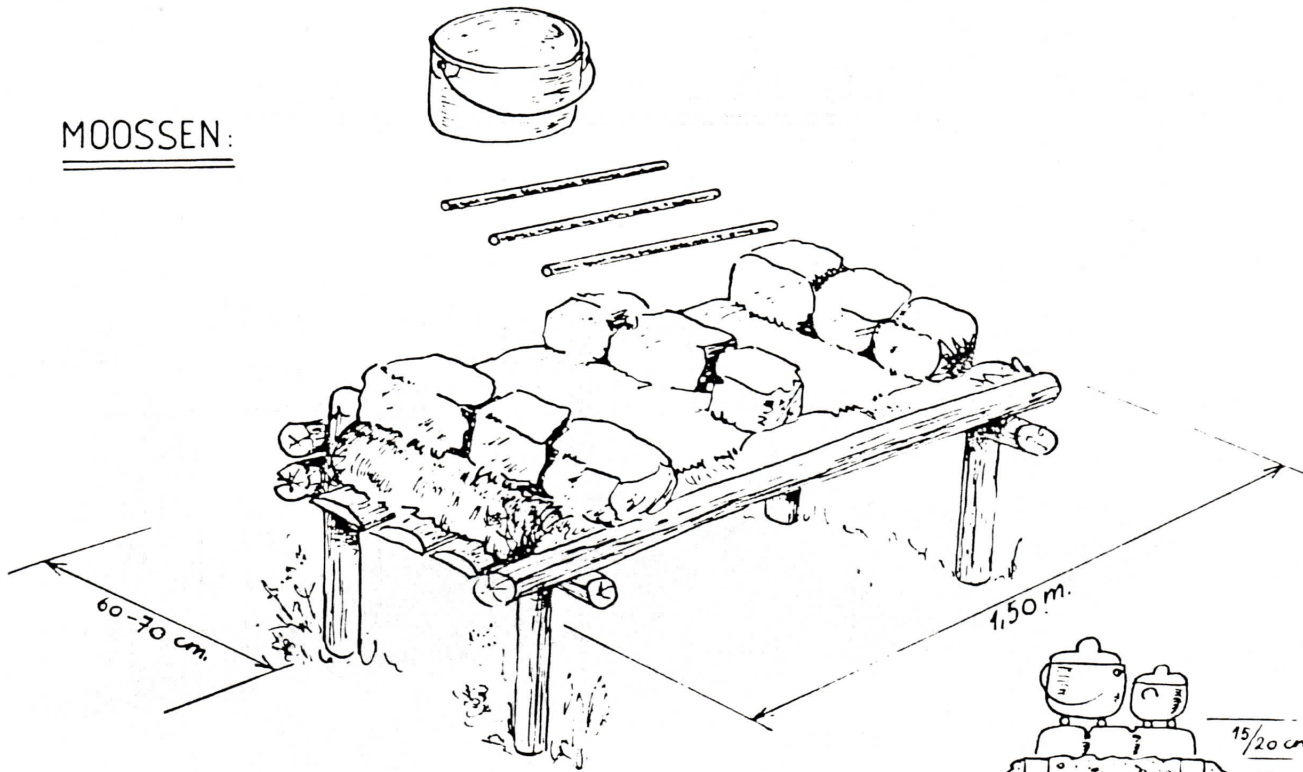

BEISPILLER:

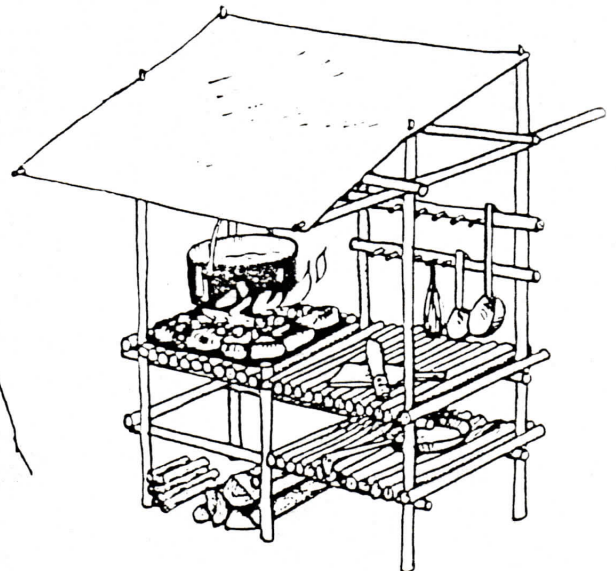
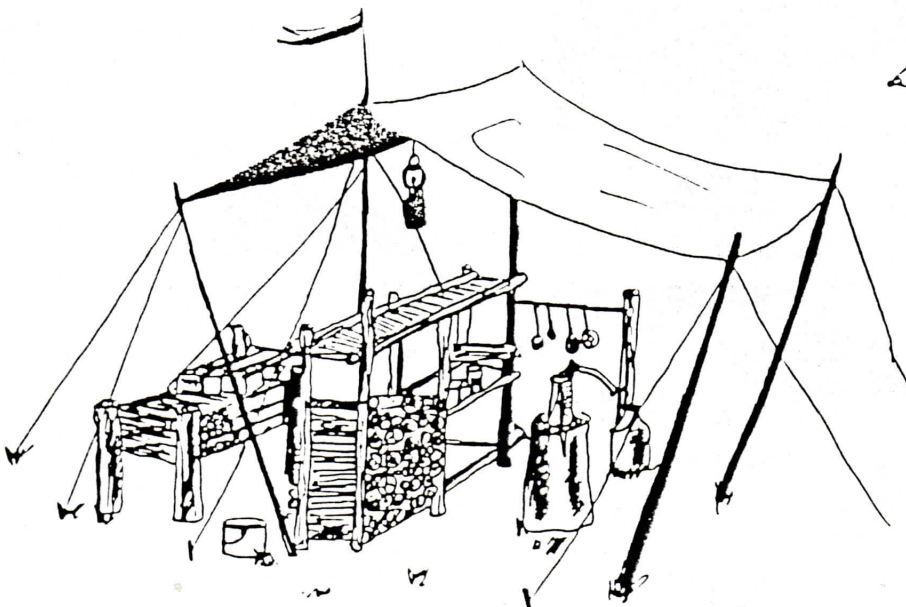
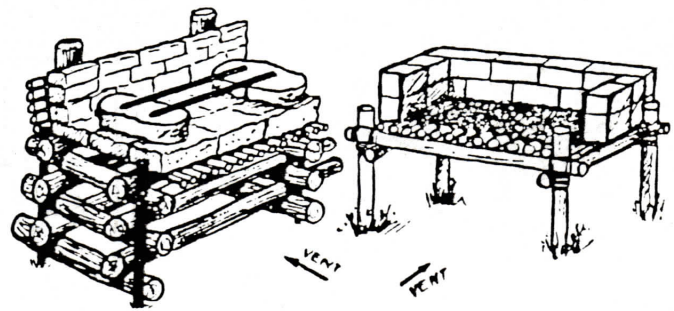
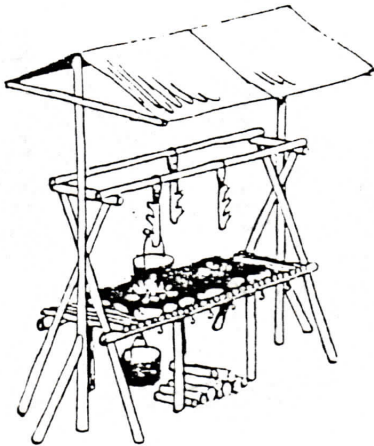

### 3) SPULL-AN GESCHIRRPLATZEN

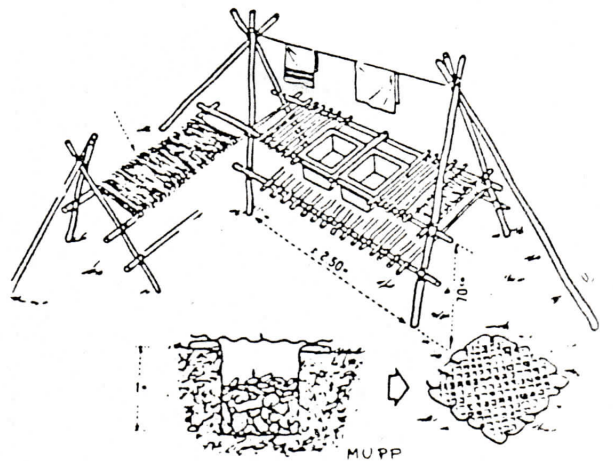
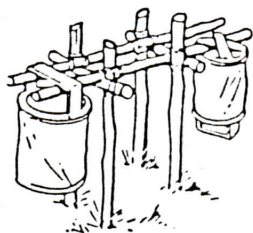
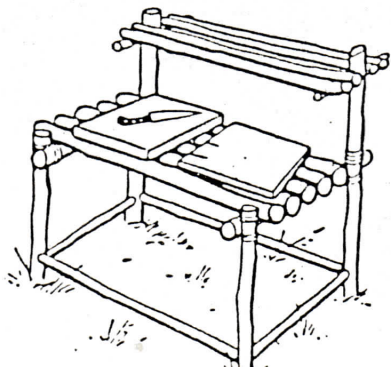
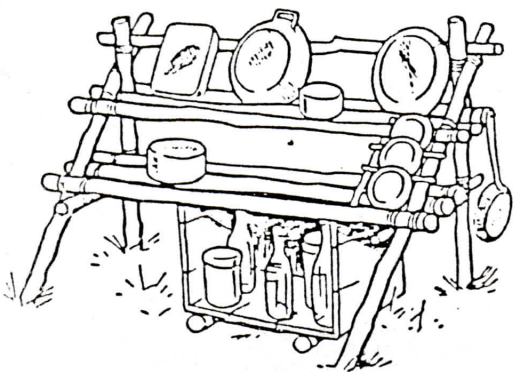
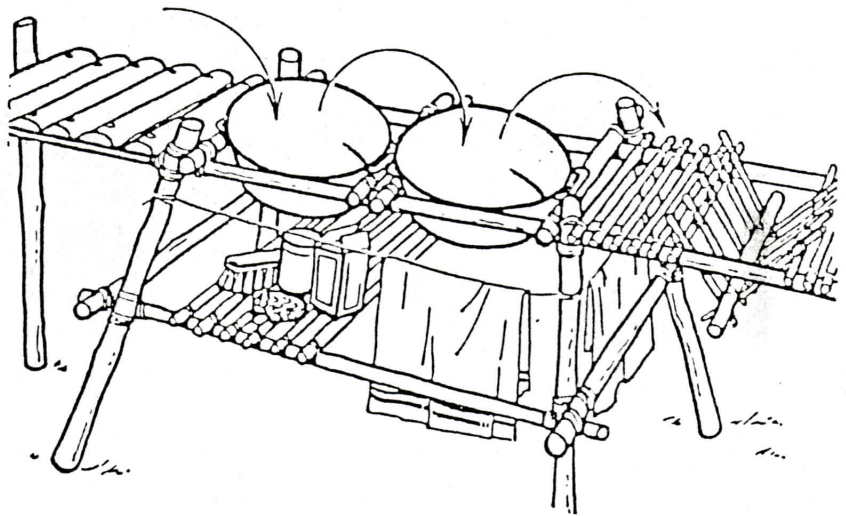
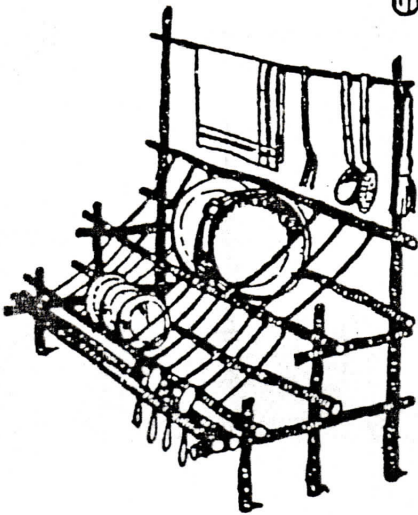
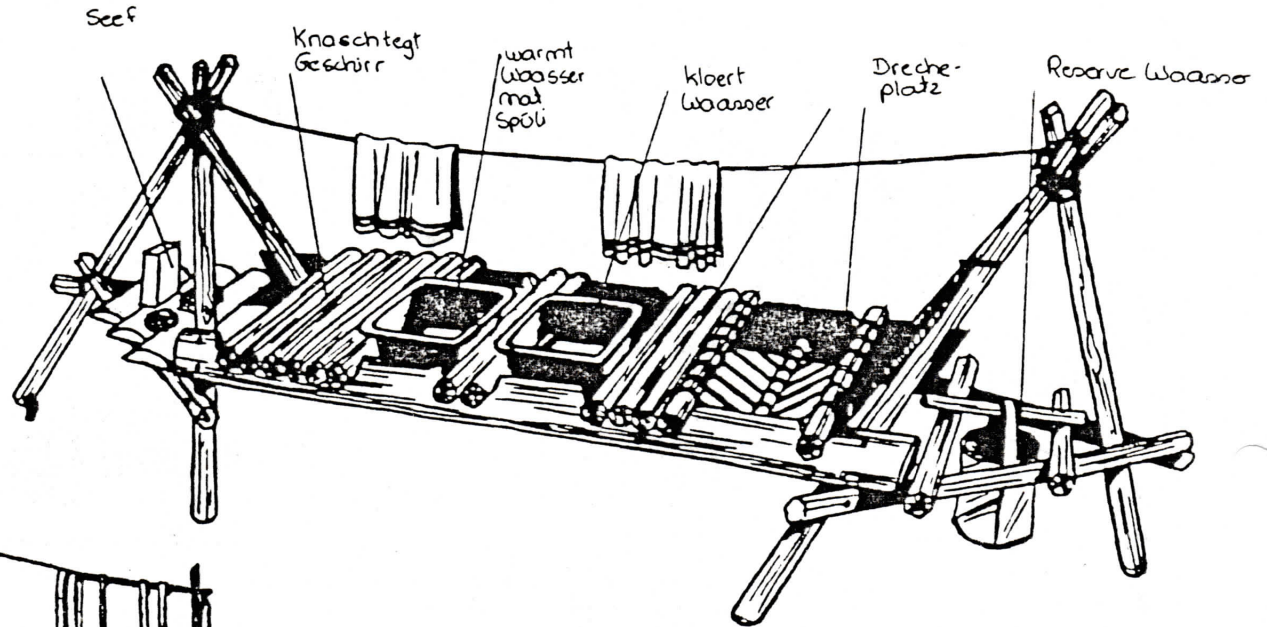

#### 4) WÄSCHPLATZEN

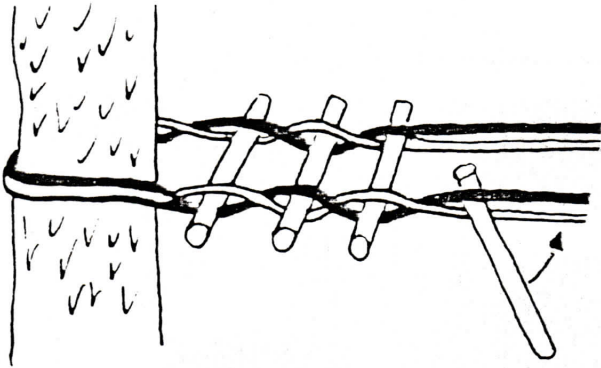

1) Vir d'WAESCHBITCHEN drop ze stellen, brauchen mir 2 Bëmm an 2 Seler. De' gin ronderom gedre't an an all Knuet get an zolde Bengel gestach :

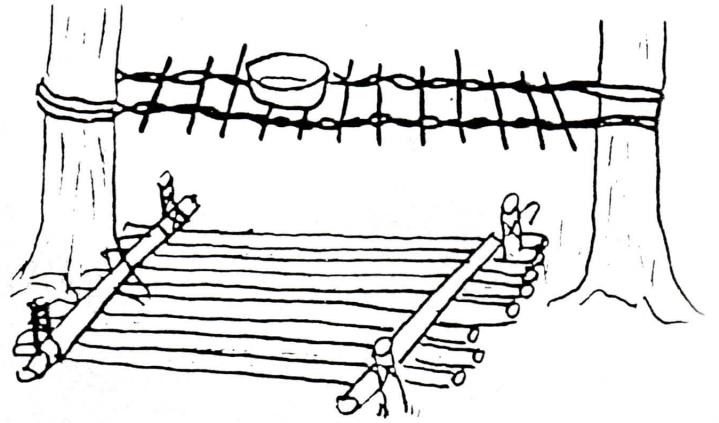

2) op de BUEDEM machen mir aus Bengelen eng Bretsch vir net mat de Fe'iss an der Netz ze stoen .

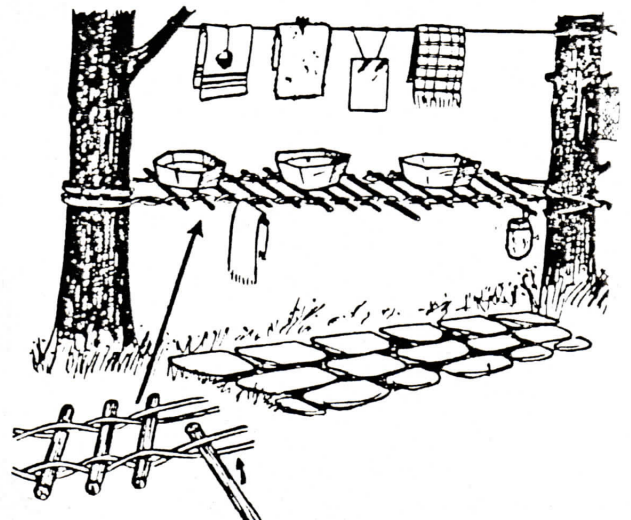
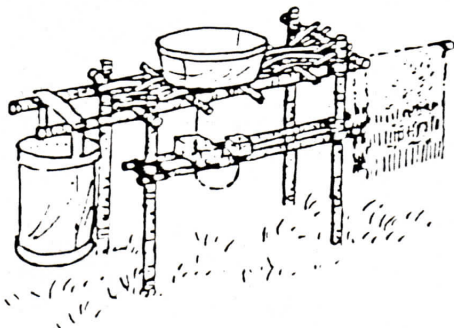
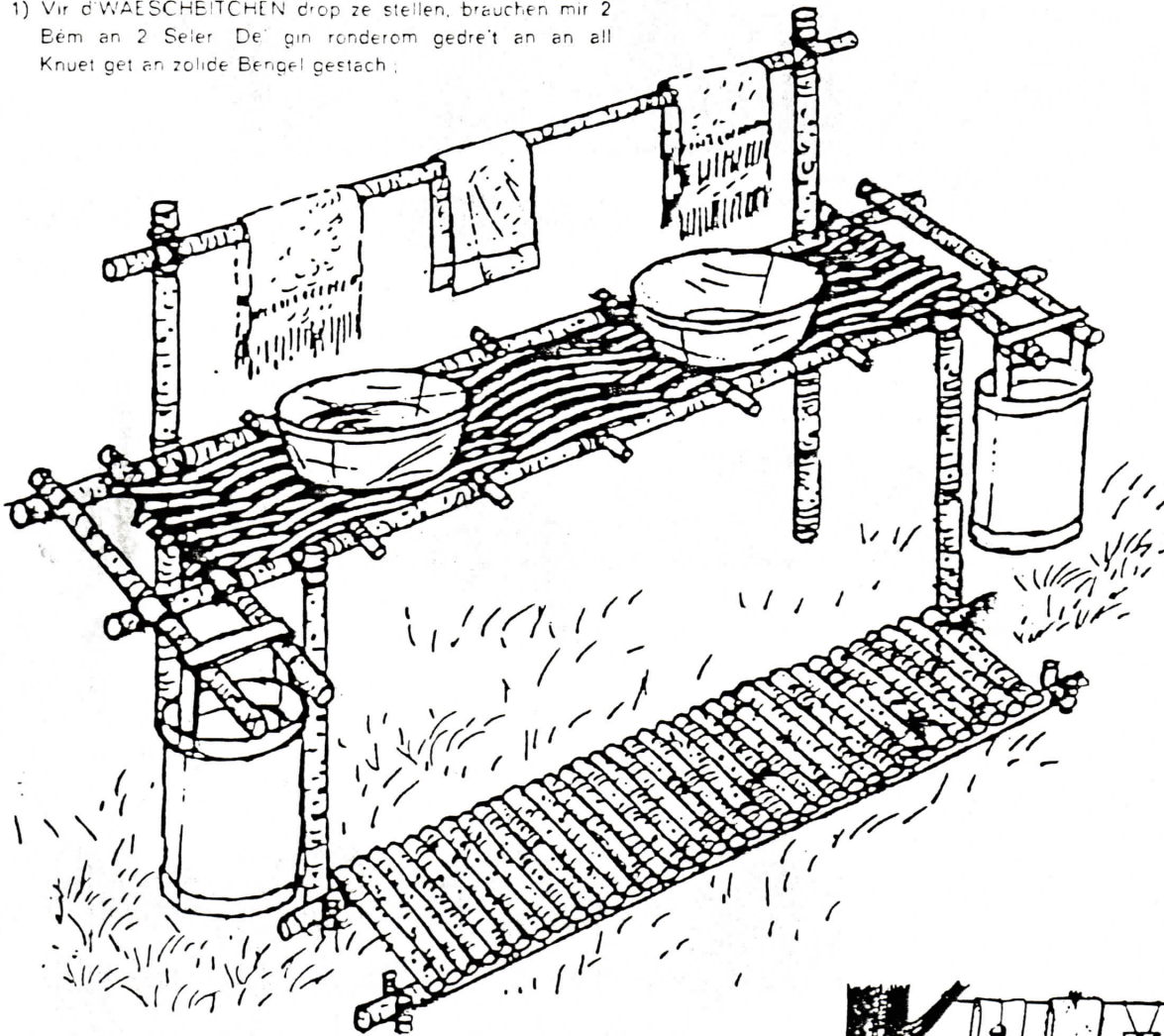

5) ALLGEMENGES

